

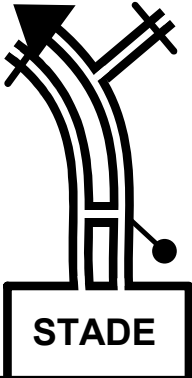

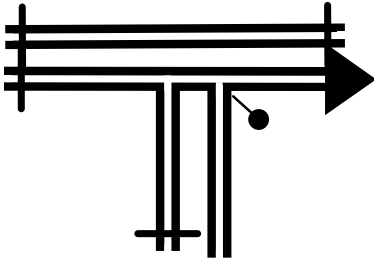

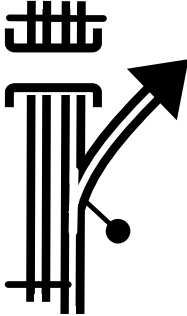

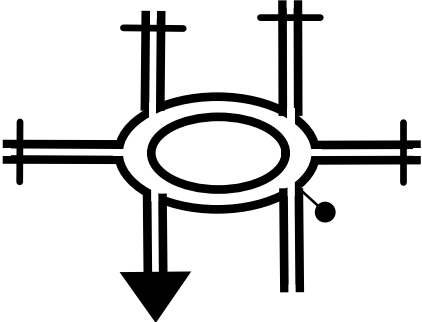

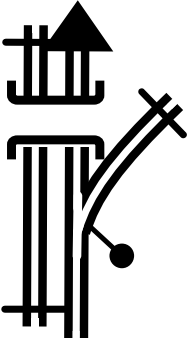
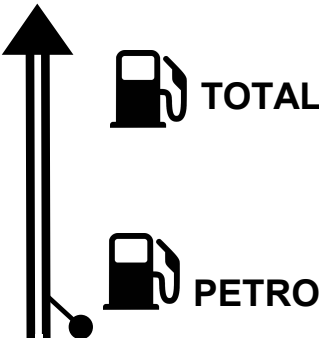

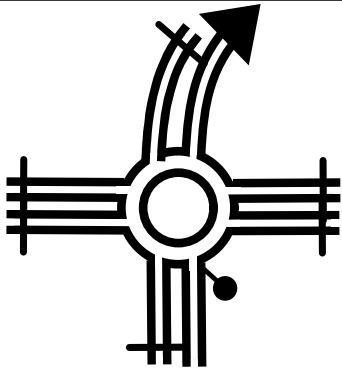
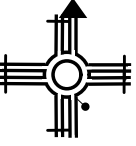
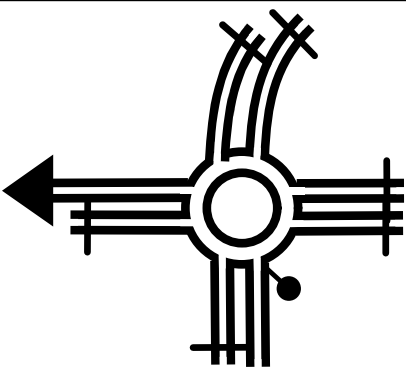

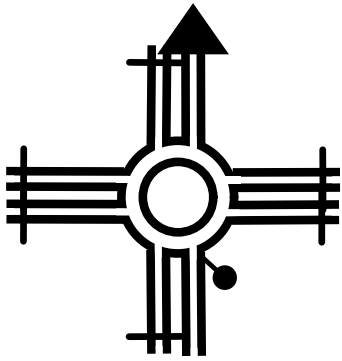

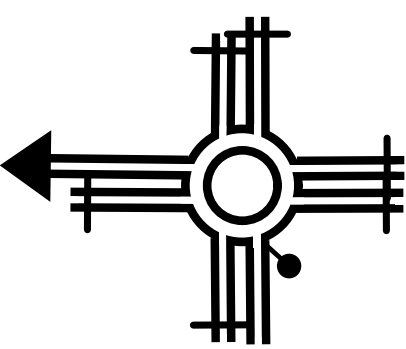

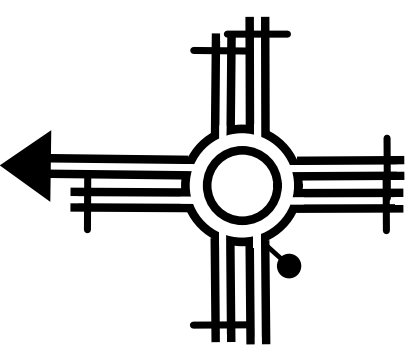
1	RALLY DU MAROC 2022 / PRIVATE TEST / SERVICE RB	Km : 45,60
<p data-bbox="129 210 384 331"><b>0,00</b></p> <p data-bbox="70 405 268 501"><b>0,00</b></p>		
<p data-bbox="129 602 384 723"><b>1,16</b></p> <p data-bbox="70 797 268 893"><b>1,16</b></p>		
<p data-bbox="129 994 384 1115"><b>1,35</b></p> <p data-bbox="70 1189 268 1285"><b>0,19</b></p>		<p data-bbox="1275 1066 1453 1149"><b>KpR</b></p>
<p data-bbox="129 1386 384 1507"><b>1,55</b></p> <p data-bbox="70 1581 268 1677"><b>0,20</b></p>		
<p data-bbox="129 1778 384 1899"><b>4,58</b></p> <p data-bbox="70 1973 268 2069"><b>3,03</b></p>		

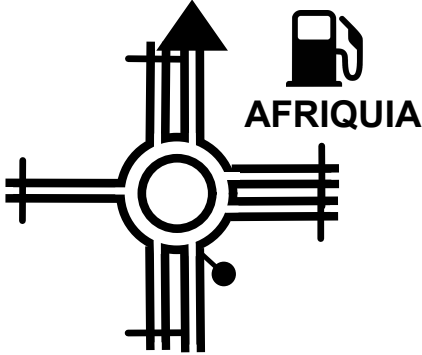
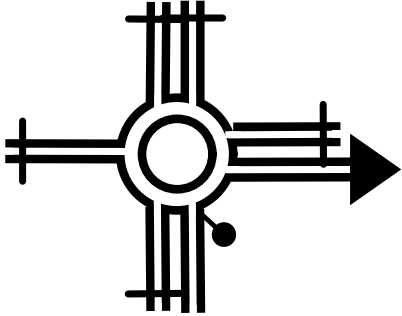
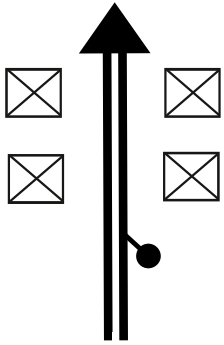

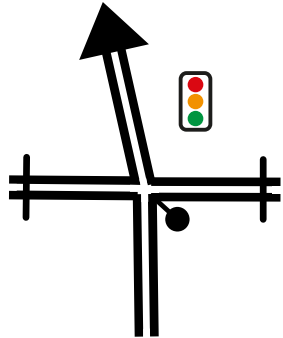
**Next 1,17**

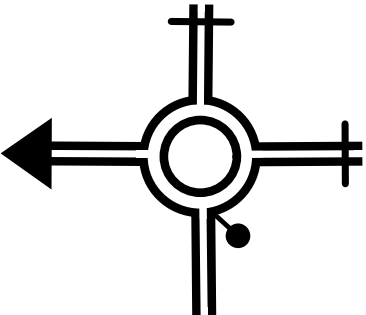
2	RALLY DU MAROC 2022 / PRIVATE TEST / SERVICE RB	Km : 45,60
5,75		
1,17		
8,26		<b>NBX</b>  <b>TJS TD</b>
9,73		 <b>AEROPORT</b>
1,47		 <b>AEROPORT</b>
12,58		 <b>AEROPORT</b>
1,83		 <b>AEROPORT</b>

**Next 6,61**

3	RALLY DU MAROC 2022 / PRIVATE TEST / SERVICE RB	Km : 45,60
<p><b>21,02</b></p>		<p><b>KpS</b></p>
<p><b>6,61</b></p>		<p><b>➔</b> <b>BIOUGRA</b></p>
<p><b>25,88</b></p>		
<p><b>4,86</b></p>		
<p><b>37,38</b></p>		
<p><b>11,50</b></p>		
<p><b>37,79</b></p>		
<p><b>0,41</b></p>		
<p><b>38,31</b></p>		
<p><b>0,52</b></p>		

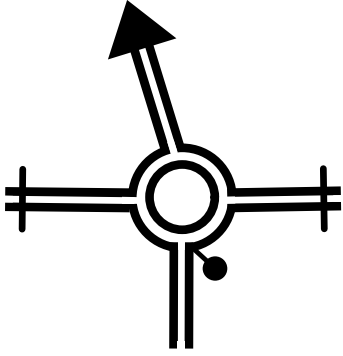
**Next 1,05**

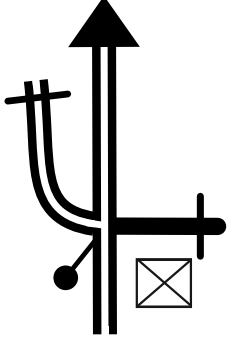
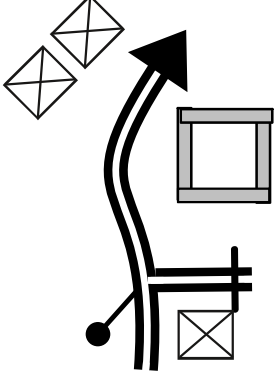
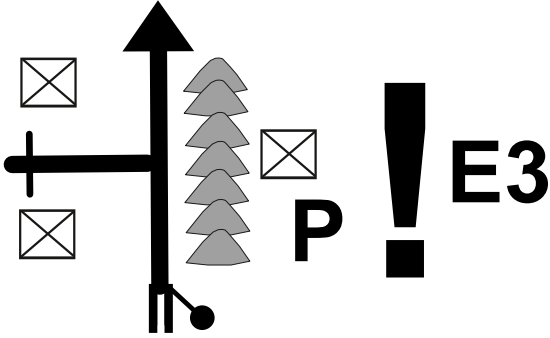
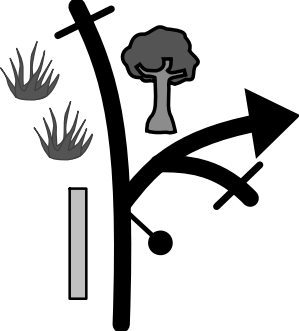
4	RALLY DU MAROC 2022 / PRIVATE TEST / SERVICE RB	Km : 45,60
<p data-bbox="92 210 424 331"><b>39,36</b></p> <p data-bbox="76 405 272 504"><b>1,05</b></p>		
<p data-bbox="92 602 424 723"><b>41,60</b></p> <p data-bbox="76 797 272 896"><b>2,24</b></p>		
<p data-bbox="92 996 424 1117"><b>44,31</b></p> <p data-bbox="76 1191 272 1290"><b>2,71</b></p>		
<p data-bbox="92 1391 424 1512"><b>45,09</b></p> <p data-bbox="76 1585 272 1684"><b>0,78</b></p>		
<p data-bbox="92 1785 424 1906"><b>45,36</b></p> <p data-bbox="76 1980 272 2078"><b>0,27</b></p>		

**Next 0,25**

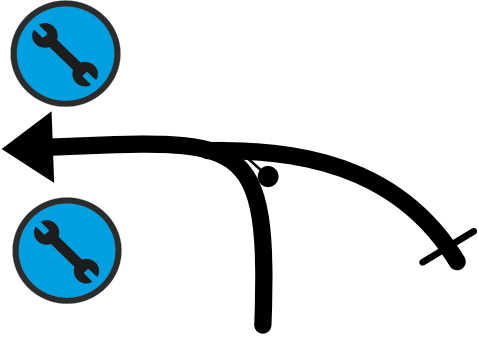
5	RALLY DU MAROC 2022 / PRIVATE TEST / SERVICE RB	Km : 45,60
45,61		
0,25		

**Next**

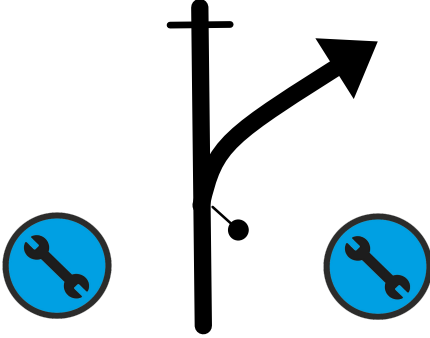
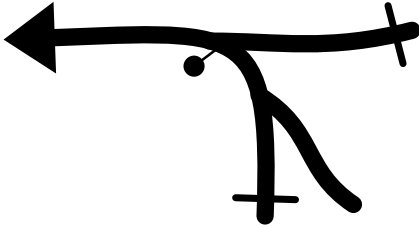
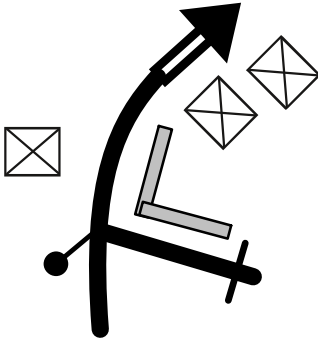
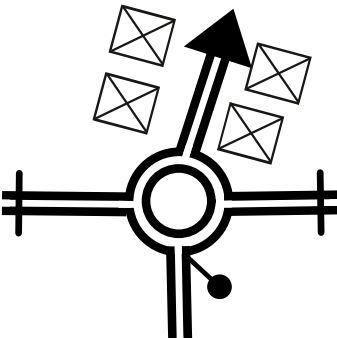
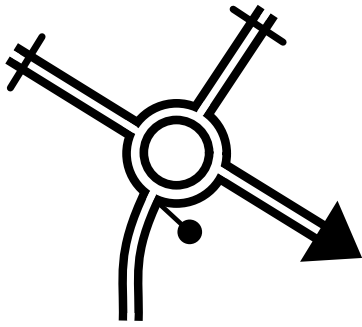
1	RALLY DU MAROC / PRIVATE TEST / SERVICE RB	Km : 44,54
<p data-bbox="129 210 384 331">0,00</p>		
<p data-bbox="71 409 268 499">0,00</p>		
<p data-bbox="129 602 384 723">0,25</p>		<p data-bbox="1241 1081 1508 1149">ET RO</p>
<p data-bbox="71 1193 268 1283">0,23</p>		<p data-bbox="1295 1352 1535 1576">30</p>
<p data-bbox="129 1386 384 1507">6,18</p>		<p data-bbox="1279 1733 1519 1957">30</p> <p data-bbox="1284 2000 1465 2067">FRO</p>
<p data-bbox="71 1977 268 2067">1,05</p>		

Next 0,74

2

RALLY DU MAROC / PRIVATE TEST / SERVICE RB

Km : 44,54

7,97

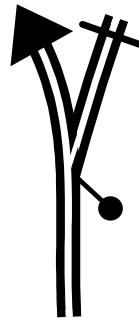

0,74

8,36

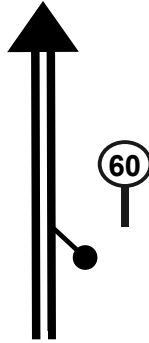

0,39

13,25

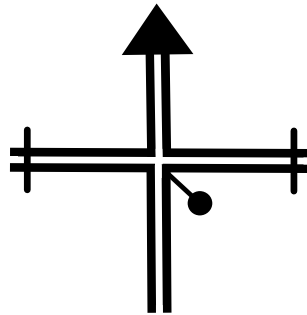

4,89

19,63

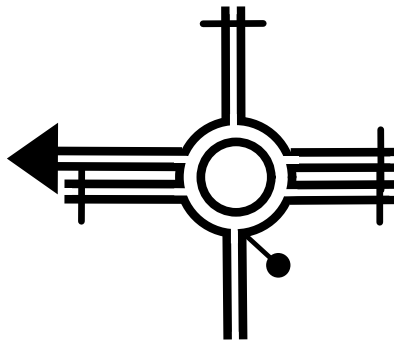

6,38

24,56

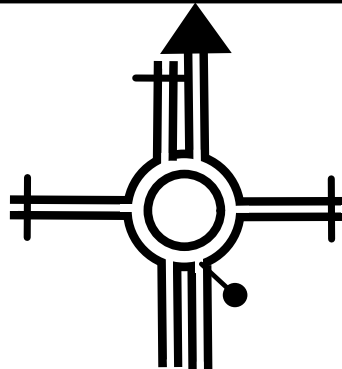

4,93

Next 6,55

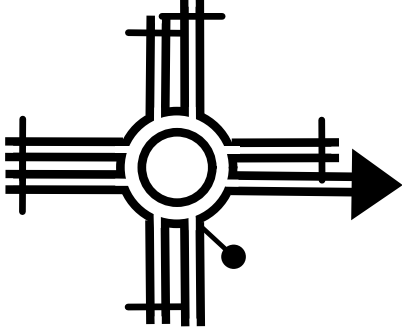
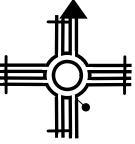
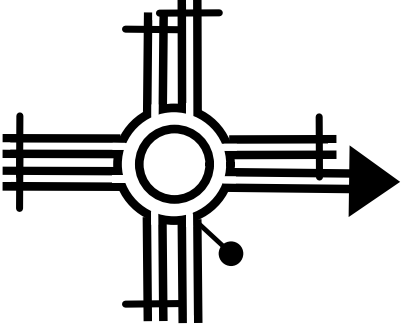
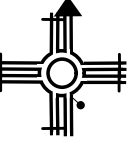
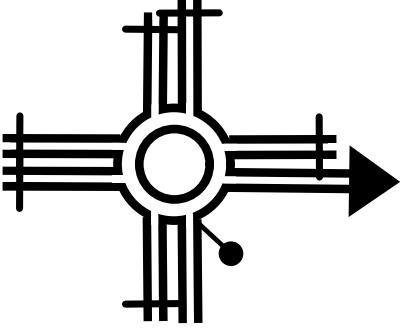
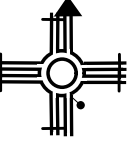
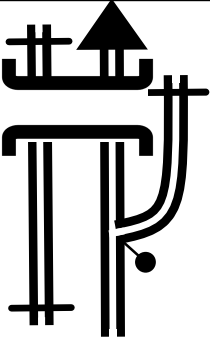
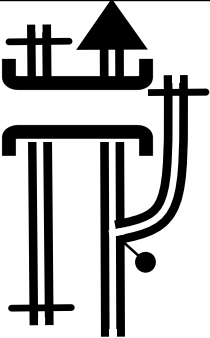
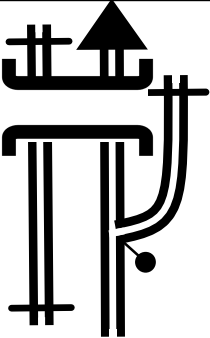
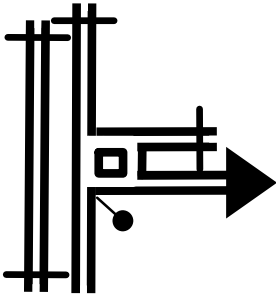
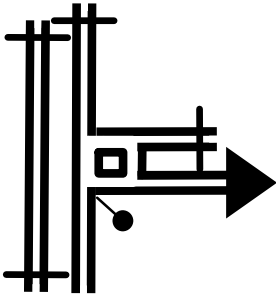
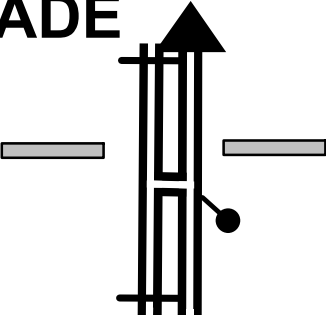
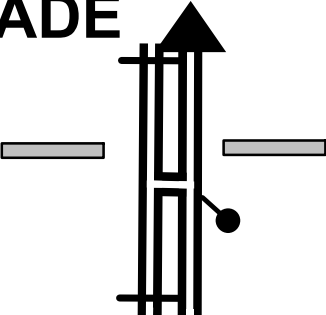
3	RALLY DU MAROC / PRIVATE TEST / SERVICE RB	Km : 44,54
<p><b>31,11</b></p>		<p>➔ <b>AGADIR</b> <b>NBX</b>  <b>TJS KpS</b></p>
<p><b>6,55</b></p>		<p><b>NBX</b>  <b>TJS KpS</b></p>
<p><b>35,74</b></p>		<p><b>NBX</b>  <b>TJS KpS</b></p>
<p><b>4,63</b></p>		
<p><b>40,35</b></p>		
<p><b>4,61</b></p>		
<p><b>43,37</b></p>		
<p><b>3,02</b></p>		
<p><b>44,54</b></p>	<p><b>STADE</b> </p>	
<p><b>1,17</b></p>		

**Next 1,17**